



**BERLI**<sup>®</sup>  
P R O F E S S I O N A L

**CKT/SB**  
**PARK/SB**  
**RA/SB**  
**TFB/SB**



**Decespugliatrici idrauliche per escavatori da 3,5 a 13 ton.**



**Hydraulic mulching heads for excavators from 3,5 to 13 tons.**



**Hydraulische Mulcherköpfe für Bagger von 3,5 bis 13 Tonnen.**



**Têtes de broyage hydrauliques pour pelles de 3,5 à 13 tonnes.**



**Desbrozadoras hidráulicas para excavadoras de 3,5 a 13 toneladas.**



L'esperienza ventennale nel settore delle macchine industriali permette alla ditta Berti di offrire alla sua clientela una gamma completa di attrezzature tecnologicamente avanzate al servizio di operatori sempre più esigenti e specializzati.

La qualità dei prodotti fin dalla materia prima, la robustezza, l'affidabilità, hanno dato vita al largo consenso che queste macchine hanno ricevuto in tutto il mondo. Inoltre la Berti vi offre tutti prodotti certificati secondo le direttive CE.



The over 20 years of skill in the manufacturing of industrial machines makes it possible for BERTI Company to offer a complete range of technologically advanced implements, to serve more and more demanding and specialized requirements. The high quality of the products, the choice of qualified sturdy and reliable materials are the main reasons of the successes that these implements have gained all over the world. Furthermore BERTI supplies all the machines certified according to EC regulations.





Die Firma Berti hat über 20 Jahre Erfahrung auf dem Gebiet der industriellen Maschinen und ist demnach imstande, ihren zahlreichen Kunden eine komplette Palette von technologisch fortgeschrittenen Geräten zu Verfügung zu stellen. Die Produktqualität, gekennzeichnet durch die Wahl von Rohstoffen erster Klasse, die Beständigkeit und die Zuverlässigkeit der Geräte, hat die Firma in die Lage gesetzt, diese in der ganzen Welt einzusetzen. Ausserdem sind alle Berti-Produkte laut den EG-Richtlinien gebaut und zertifiziert.

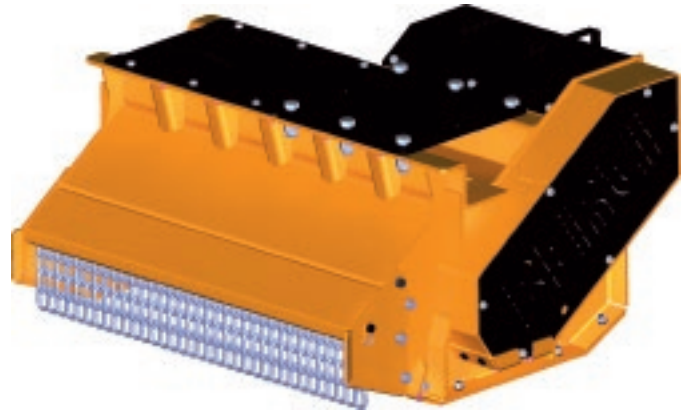

L'expérience de plus de 20 ans dans le monde de la machine industrielle permet à la firme Berti d'offrir à ses clients une gamme complète d'équipements technologiquement à l'avantgarde au service des opérateurs exigeants et professionnels. La qualité des produits à partir de la matière première, la résistance et la fiabilité ont permis à nos machines d'obtenir un accueil très favorable dans le monde entier. Tous les produits de la firme Berti sont certifiés selon les directives CEE.



La empresa Berti cuenta con una experiencia de 20 años en el sector de las máquinas industriales, que le permite ofrecer a sus clientes una gama completa de equipos tecnológicamente avanzados al servicio de operadores cada vez más exigentes y especializados. La calidad de los productos a partir de la materia prima, la robustez y la fiabilidad están en la base de la aceptación que reciben estas máquinas en todo el mundo. Además, todos los productos Berti están certificados conforme a las directivas CE.

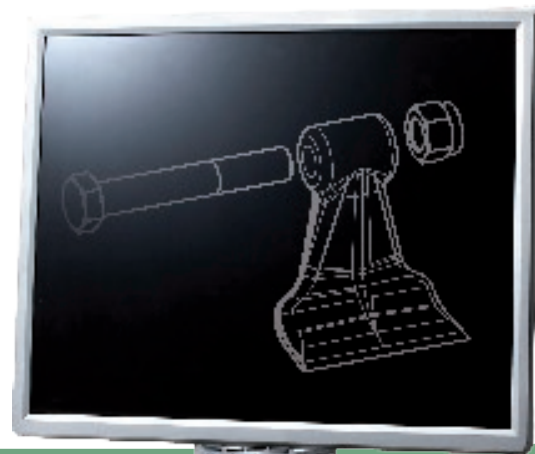

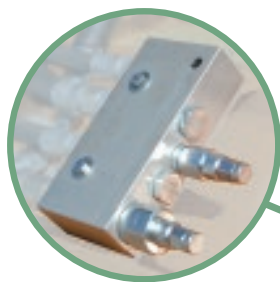

# CKT/SB



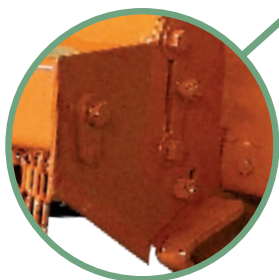

- Blocco valvole "Berti Fluid Box" (max 100 lt/min).
- Hydr. valves block, "Berti Fluid Box" (max 100 lt/min).
- Hydr. Ventilenblock "Berti Fluid Box" (max 100 lt/min).
- Group clapets "Berti Fluid-Box" (max 100 lt/min).
- Bloque válvulas "Berti Fluid Box" (máx. 100 l/min).

- Cofano frontale apribile per ispezione.
- Front hood, removable for inspection.
- Abnehmbare Haube (vorder), für Wartung.
- Capot avant amovible pour inspection.
- Capó delantero que puede abrirse para inspecciones.









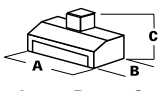

 Decespugliatrice idraulica per mini-escavatori, con peso operativo compreso fra 3,5 e 5,5 tonnellate, adatta a trinciare erba, rovi e piccoli arbusti fino a  $\varnothing$  4 cm. Compatta e di alte prestazioni, viene utilizzata in svariati settori quali edilizia, manutenzione del verde pubblico e privato, agricoltura, ecc.

 Tête de broyage hydraulique pour mini-pelles de 3,5 à 5,5 tonnes, conçue pour broyer l'herbe, les tiges et les buissons allant jusqu'à un diamètre de 4 cm. Compacte et très performante, cette machine peut être utilisée pour l'entretien des espaces verts, agriculture, etc.

 Hydraulic mulching head for mini-excavators of 3,5 - 5,5 tons, suited for mulching grass, bushes and scrub up to  $\varnothing$  4 cm. Compact and high performing, it can be used for several purposes such as pre-construction clearing, public and private green maintenance, agriculture, etc.

 Cabezal desbrozador de accionamiento hidráulico para mini-excavadoras de 3,5 a 5,5 toneladas. Apta para la trituración o desbroce de hierba, arbustos y material leñoso de hasta 4 cm de diámetro. Su compacidad y razonable rendimiento le hacen ideal para el mantenimiento de zonas verdes públicas o privadas, usos agrícolas, limpieza de terrenos destinados a la construcción, etc.

 Hydraulischer Mulchkopf für Minibagger von 3,5 - 5,5 Tonnen. Geeignet für Gras, Büsche und kleine Äste bis zu einem Durchmesser von 4 cm. Leistungsstark und kompakt, Anwendungsgebiete sind bspw. das Bauwesen, die Grünflächenpflege von Kommunen und Privat, Landwirtschaft etc.

Mod.											
	A	B	C								
<b>CKT/SB 80</b>	95	84	58	80	2	12	36	43-47	195-205	235	25
<b>CKT/SB 100</b>	115	84	58	100	2	16	48	43-47	195-205	265	25

\* Il peso è riferito alla macchina standard (senza accessori) • The weight refers to the machine with standard equipment (without accessories) • Die Gewichtsangabe bezieht sich auf die Maschine in Grundausstattung (ohne Sonderausstattung) • Le poids se réfère à la machine standard (sans accessoires) • El peso se refiere al estándar de la máquina (sin accesorios).



- Motore ad ingranaggi (a richiesta con o senza drenaggio).
- Geared motor (with or without drainage line on request).
- Zahnradmotor (mit oder ohne Drainage auf Anfrage).
- Moteur à engrenages (avec ou sans drainage externe sur demande).
- Motor de engranajes (con o sin drenaje externo bajo petición).



- Trasmissione laterale a cinghie e carter protezione motore.
- Belts transmission and protective cover for motor.
- Keilriemenantrieb und Gehäuse für Schutz des Motor.
- Transmission par courroies et carter de protection moteur.
- Transmisión lateral de correas y cubierta de protección del motor.



- Rullo livellatore d'appoggio regolabile.
- Adjustable levelling roller.
- Einstellbare Stützwalze.
- Rouleau palpeur, réglable en hauteur.
- Rodillo nivelador de apoyo regulable.



- Supporto autolivellante per sella d'attacco.
- Self-levelling support for mounting hitch.
- Selbstnivellierender Unterlage für Anbau.
- Support auto nivelant pour selle d'attelage.
- Soporte de autonivelación para asiento de enganche.

**OPTIONAL**



Optional



- Sella d'attacco su misura completa di perni.
- Mounting hitch & pins, made to measure.
- Anbauplatte mit Zapfen (Masse durchgeben).
- Selle d'attelage faite sur mesure avec axes.
- Asiento de enganche a la medida, con pernos.



# PARK/SB





- Cofano frontale apribile per ispezione.
- Front hood, removable for inspection.
- Abnehmbare Haube (vorder), für Wartung.
- Capot avant amovible pour inspection.
- Capó delantero que puede abrirse para inspecciones.



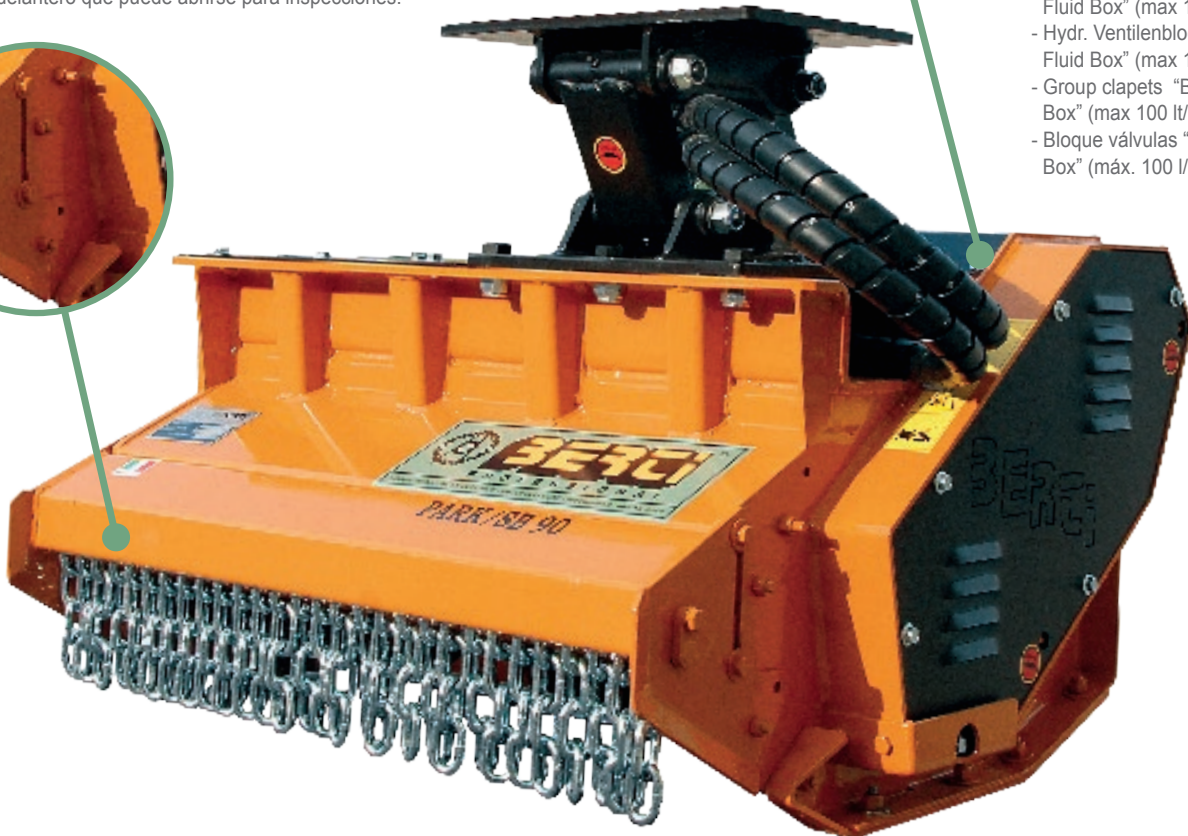

- Blocco valvole "Berti Fluid Box" (max 100 lt/min).
- Hydr. valves block, "Berti Fluid Box" (max 100 lt/min).
- Hydr. Ventilenblock "Berti Fluid Box" (max 100 lt/min).
- Group clapets "Berti Fluid-Box" (max 100 lt/min).
- Bloque válvulas "Berti Fluid Box" (máx. 100 l/min).









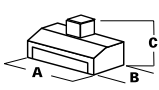

 Decespugliatrice idraulica per mini escavatori con peso operativo da 5,5 a 8 tonnellate. Adatta per la trinciatura di erba, canneto, rovi e cespugli con vegetazione legnosa fino a  $\varnothing$  5 cm.

 Tête de broyage hydraulique pour mini-pelles de 5,5 à 8 tonnes, conçue pour broyer l'herbe, les tiges, les déchets végétaux et les buissons allant jusqu'au diamètre de 5 cm.

 Hydraulic mulching head for mini-excavators of 5,5 - 8 tons suited to mulch grass, canes, bushes and pruning up to  $\varnothing$  5 cm.

 Cabezal desbrozador de accionamiento hidráulico para mini-excavadoras de 5,5 a 8 toneladas. Apta para la trituración o desbroce de hierba, arbustos y material leñoso de hasta 5 cm de diámetro.

 Hydraulischer Mulchkopf für Minibagger von 5,5 - 8 Tonnen. Geeignet für Gras, Büsche und Äste bis zu einem Durchmesser von 5 cm.

Mod.											
	A	B	C								
<b>PARK/SB 90</b>	107	91	90	90	2	12	36	63-67	215-225	435	50
<b>PARK/SB 110</b>	127	91	90	110	2	16	48	63-67	215-225	465	50

\* Il peso è riferito alla macchina standard (senza accessori) • The weight refers to the machine with standard equipment (without accessories) • Die Gewichtsangabe bezieht sich auf die Maschine in Grundausstattung (ohne Sonderausstattung) • Le poids se réfère à la machine standard (sans accessoires) • El peso se refiere al estándar de la máquina (sin accesorios).

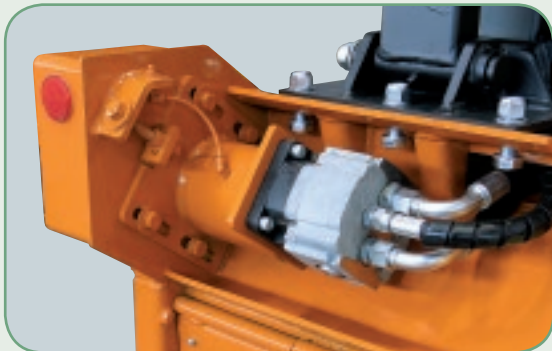

- Motore ad ingranaggi (a richiesta con o senza drenaggio).
- Geared motor (with or without drainage line on request).
- Zahnradmotor (mit oder ohne Drainage auf Anfrage).
- Moteur à engrenages (avec ou sans drainage externe sur demande).
- Motor de engranajes (con o sin drenaje externo bajo petición).



- Trasmissione laterale a cinghie e carter protezione motore.
- Belts transmission and protective cover for motor.
- Keilriemenantrieb und Gehäuse für Schutz des Motor.
- Transmission par courroies et carter de protection moteur.
- Transmisión lateral de correas y cubierta de protección del motor.



- Rullo livellatore d'appoggio regolabile.
- Adjustable levelling roller.
- Einstellbare Stützwalze.
- Rouleau palpeur, réglable en hauteur.
- Rodillo nivelador de apoyo regulable.



- Supporto autolivellante per sella d'attacco.
- Self-levelling support for mounting hitch.
- Selbstnivellierender Unterlage für Anbau.
- Support auto nivelant pour selle d'attelage.
- Soporte de autonivelación para asiento de enganche.

**OPTIONAL**



- Sella d'attacco su misura completa di perni.
- Mounting hitch & pins, made to measure.
- Anbauplatte mit Zapfen (Masse durchgeben).
- Selle d'attelage faite sur mesure avec axes.
- Asiento de enganche a la medida, con pernos.



Optional



# RA/SB



- Blocco valvole "Berti Fluid Box" (max 120 l/min).
- Hydr. valves block, "Berti Fluid Box" (max 120 l/min).
- Hydr. Ventilenblock "Berti Fluid Box" (max 120 l/min).
- Group clapets "Berti Fluid-Box" (max 120 l/min).
- Bloque válvulas "Berti Fluid Box" (máx. 120 l/min).

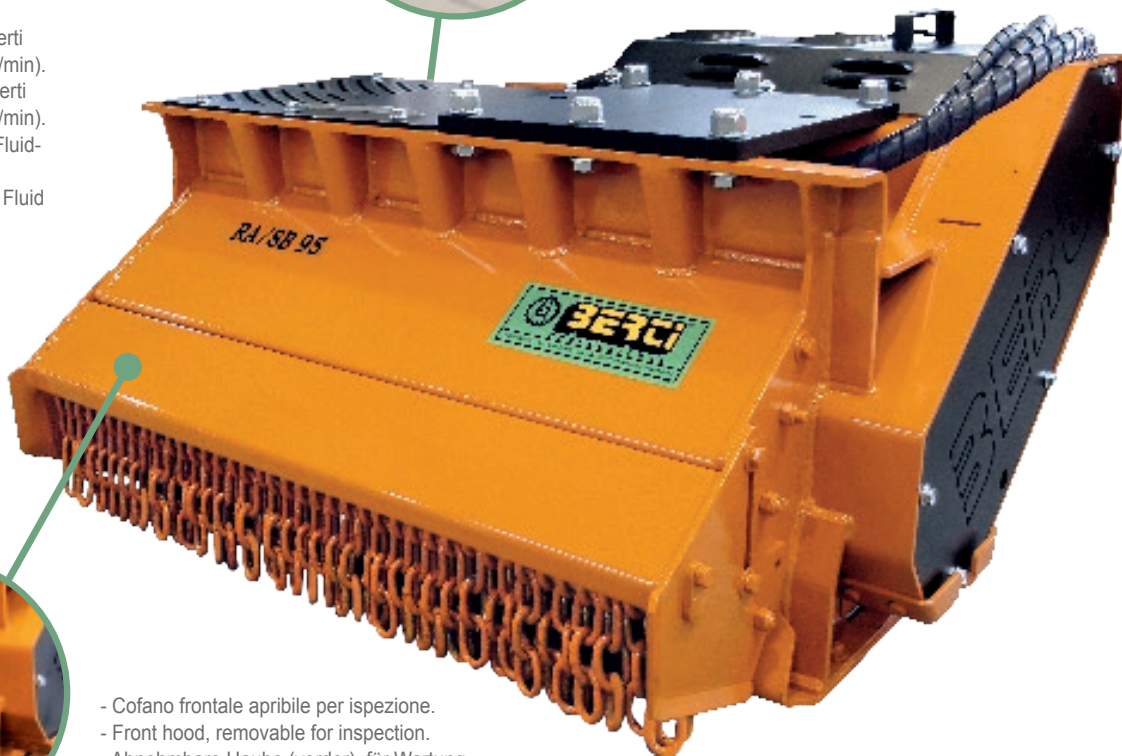

- Cofano frontale apribile per ispezione.
- Front hood, removable for inspection.
- Abnehmbare Haube (vorder), für Wartung.
- Capot avant amovible pour inspection.
- Capó delantero que puede abrirse para inspecciones.



Testata trincante idraulica robusta e compatta per escavatori con peso operativo compreso fra 7 e 9 tonnellate. E' adatta ad eseguire lavori di decespugliazione su erba, canneto, rovi e cespugli con vegetazione legnosa fino a  $\varnothing$  6 cm.



Tête de broyage hydraulique à monter sur pelles allant de 7 à 9 tonnes, conçue pour nettoyer et broyer l'herbe, les buissons et les tiges jusqu'au diamètre de 6 cm.



Hydraulic mulching head to be driven by excavators of 7-9 tons, suited for clearing and cutting purposes such as grass, canes, bushes and pruning up to  $\varnothing$  6 cm.



Cabezal desbrozador de accionamiento hidráulico para retroexcavadoras de 7 a 9 toneladas. Apto para la trituración o desbroce de hierba, arbustos, ramas y restos de poda de hasta 6 cm de diámetro.



Robuster und kompakter hydraulischer Mulchkopf für Bagger von 7-9 Tonnen. Geeignet für Gras, Büsche und Äste bis zu einem Durchmesser von 6 cm.

Mod.												
	A	B	C									
<b>RA/SB 95</b>	115	94	69	95	3	8	24	78-82	215-225	430	50	65
<b>RA/SB 115</b>	135	94	69	115	3	10	30	78-82	215-225	470	50	65
<b>RA/SB 125</b>	145	94	69	125	3	12	36	78-82	215-225	485	50	65

\* Il peso è riferito alla macchina standard (senza accessori) • The weight refers to the machine with standard equipment (without accessories) • Die Gewichtsangabe bezieht sich auf die Maschine in Grundausstattung (ohne Sonderausstattung) • Le poids se réfère à la machine standard (sans accessoires) • El peso se refiere al estándar de la máquina (sin accesorios).



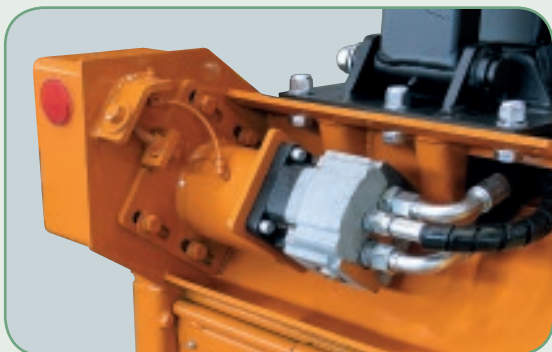

- Motore ad ingranaggi (a richiesta con o senza drenaggio).
- Geared motor (with or without drainage line on request).
- Zahnradmotor (mit oder ohne Drainage auf Anfrage).
- Moteur à engrenages (avec ou sans drainage externe sur demande).
- Motor de engranajes (con o sin drenaje externo bajo petición).

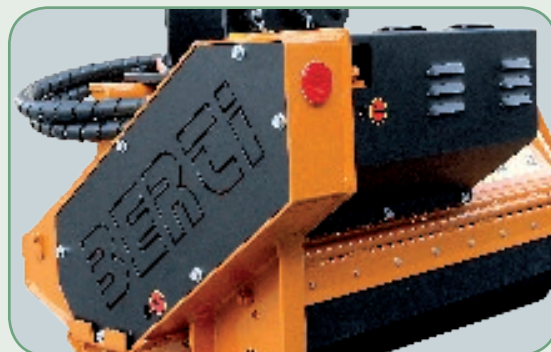

- Trasmissione laterale a cinghie e carter protezione motore.
- Belts transmission and protective cover for motor.
- Keilriemenantrieb und Gehäuse für Schutz des Motor.
- Transmission par courroies et carter de protection moteur.
- Transmisión lateral de correas y cubierta de protección del motor.



- Rullo livellatore d'appoggio regolabile.
- Adjustable levelling roller.
- Einstellbare Stützwalze.
- Rouleau palpeur, réglable en hauteur.
- Rodillo nivelador de apoyo regulable.



OPTIONAL

- Supporto autolivellante per sella d'attacco.
- Self-levelling support for mounting hitch.
- Selbstnivellierender Unterlage für Anbau.
- Support auto nivelant pour selle d'attelage.
- Soporte de autonivelación para asiento de enganche.



OPTIONAL

50 m  
 DISTANZA DI SICUREZZA  
 SAFETY DISTANCE  
 DISTANCES DE SECURITE  
 SICHERHEITSABSTAND  
 VARNOSTNÁ RAZDÁLKA



Optional

- Sella d'attacco su misura completa di perni.
- Mounting hitch & pins, made to measure.
- Anbauplatte mit Zapfen (Masse durchgeben).
- Selle d'attelage faite sur mesure avec axes.
- Asiento de enganche a la medida, con pernos.



# TFB/SB

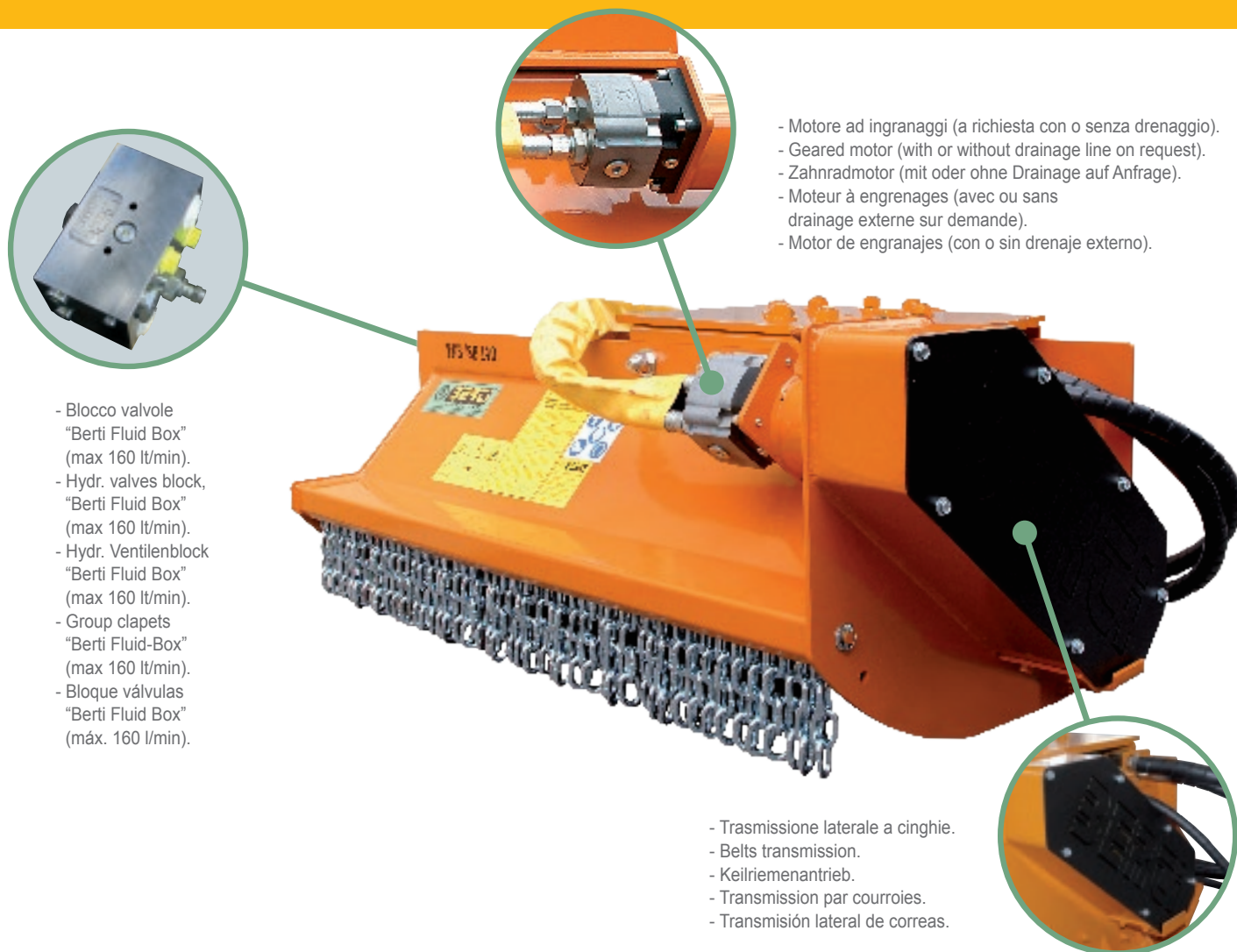

- Blocco valvole "Berti Fluid Box" (max 160 lt/min).
- Hydr. valves block, "Berti Fluid Box" (max 160 lt/min).
- Hydr. Ventilenblock "Berti Fluid Box" (max 160 lt/min).
- Group clapets "Berti Fluid-Box" (max 160 lt/min).
- Bloque válvulas "Berti Fluid Box" (máx. 160 l/min).

- Motore ad ingranaggi (a richiesta con o senza drenaggio).
- Geared motor (with or without drainage line on request).
- Zahnradmotor (mit oder ohne Drainage auf Anfrage).
- Moteur à engrenages (avec ou sans drainage externe sur demande).
- Motor de engranajes (con o sin drenaje externo).

- Trasmissione laterale a cinghie.
- Belts transmission.
- Keilriemenantrieb.
- Transmission par courroies.
- Transmisión lateral de correas.

Decespugliatrice idraulica per escavatori con peso operativo da 9 a 13 Ton, adatta ad eseguire lavori di decespugliazione su erba, canneto, rovi e cespugli con vegetazione legnosa fino a  $\varnothing$  8 cm.

Tête de broyage hydraulique compacte pour pelles de 9 à 13 tonnes conçue pour nettoyer et broyer l'herbe, les buissons et les tiges jusqu'au diamètre de 8 cm.

Compact and reliable hydraulic mulching head to be driven by excavators of 9-13 tons. suited for clearing and cutting purposes such as grass, canes, bushes and pruning up to  $\varnothing$  8 cm.

Cabezal desbrozador compacto de accionamiento hidráulico para retroexcavadoras de 9 a 13 toneladas. Apto para la trituración o desbroce de hierba, arbustos, ramas y restos de poda de hasta 8 cm de diámetro.

Hydraulische Mulchkopf für Bagger von 9-13 Tonnen. Geeignet für Gras, Büsche und Äste bis zu einem Durchmesser von 8 cm.

Mod.												
	A	B	C									
	cm	cm	cm	cm	n°	n°	n°	l/min.*	bar*	Kg**	Kg***	Kg***
<b>TFB/SB 100</b>	122	93	95	100	4	10	30	88-92	235-245	505	80	85
<b>TFB/SB 120</b>	142	93	95	120	4	12	36	88-92	235-245	555	80	85
<b>TFB/SB 140</b>	162	93	95	140	4	12	36	105-115	235-245	610	80	85
<b>TFB/SB 160</b>	182	93	95	160	4	14	42	105-115	235-245	660	80	85

\* Il peso è riferito alla macchina standard (senza accessori) • The weight refers to the machine with standard equipment (without accessories) • Die Gewichtsangabe bezieht sich auf die Maschine in Grundausstattung (ohne Sonderausstattung) • Le poids se réfère à la machine standard (sans accessoires) • El peso se refiere al estándar de la máquina (sin accesorios).



- Rullo livellatore d'appoggio regolabile.
- Adjustable levelling roller.
- Einstellbare Stützwalze.
- Rouleau palpeur, réglable en hauteur.
- Rodillo nivelador de apoyo regulable.

OPTIONAL



- Supporto autolivellante per sella d'attacco.
- Self-levelling support for mounting hitch.
- Selbstnivellierender Unterlage für Anbau.
- Support auto nivelant pour selle d'attelage.
- Soporte de autonivelación para asiento de enganche.

OPTIONAL



- Sella d'attacco su misura completa di perni.
- Mounting hitch & pins, made to measure.
- Anbauplatte mit Zapfen (Masse durchgeben).
- Selle d'attelage faite sur mesure avec axes.
- Asiento de enganche a la medida, con pernos.

OPTIONAL

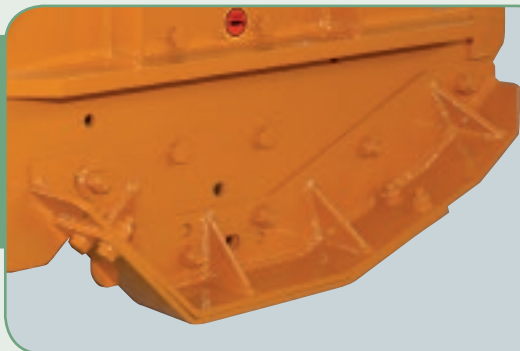

- Slitte d'appoggio con pattini antiusura sostituibili.
- Side skids with wearing undershoes.
- Jeu patins avec plaques en acier anti usure remplaçables.
- Stützkufen mit ersehbaren Verschleissplatten.
- Correderas apoyo con patines antidesgaste sustituibles.

OPTIONAL



- Motore idraulico a pistoni (l/min. 105-110, bar 260-280).
- Hydraulic piston motor (l/min. 105-110, bar 260-280).
- Hydr. Kolbenmotor (l/min. 105-110, bar 260-280).
- Moteur hydraulique à pistons (l/min. 105-110, bar 260-280).
- Motor hidráulico de pistones (l/min. 105-110, bar 260-280).



Optional





www.bertiprofessionali.it



CKT/SB



PARK/SB



RA/SB



TFB/SB

Le illustrazioni e i dati del presente catalogo sono indicative e non vincolanti per il costruttore • All pictures and data above are indicative only and not binding for the manufacturer • Alle in diesem Katalog enthaltenen Angaben und Zeichnungen sind annahmend und unverbindlich • Toutes les données insérées dans ce catalogue ont été indiquées seulement à titre de renseignement • Las fotografías y los datos mostrados son meramente indicativos y podrían ser variados sin previo aviso por el fabricante.



**BERTI**<sup>®</sup>  
MACCHINE AGRICOLE



Via Musi, 1/A-3 - 37042 Caldiero (VR) ITALY  
Tel. +39.045.6139711 - Fax +39.045.6150251  
info@bertima.it



MADE IN ITALY